Build Solar Better

Balance of System Solutions from
PV Module to Transmission Line



www.panduit.com/solar

PANDUIT[®]

Millions of Connections: Make Each a Point of Strength

Renewable Energy growth is accelerating, and solar is the star of the show. Total generating capacity is being added at over 400 GW per year globally, accounting for more than two-thirds of new Renewable Energy projects.

As the industry has matured, costs have declined across the board, except for one area – labor. A factor compounded by a shortage of skilled workers in the sector. Now, more than ever, long-term project ROI hinges on efficient deployment and predictable future maintenance and operations.



Though Electrical Balance of System (EBOS) components (excluding wire) represent less than 5% of total project costs, 60% of all downtime is caused by mistakes or component failures in the DC distribution system.

- SOLARGRADE PV HEALTH REPORT

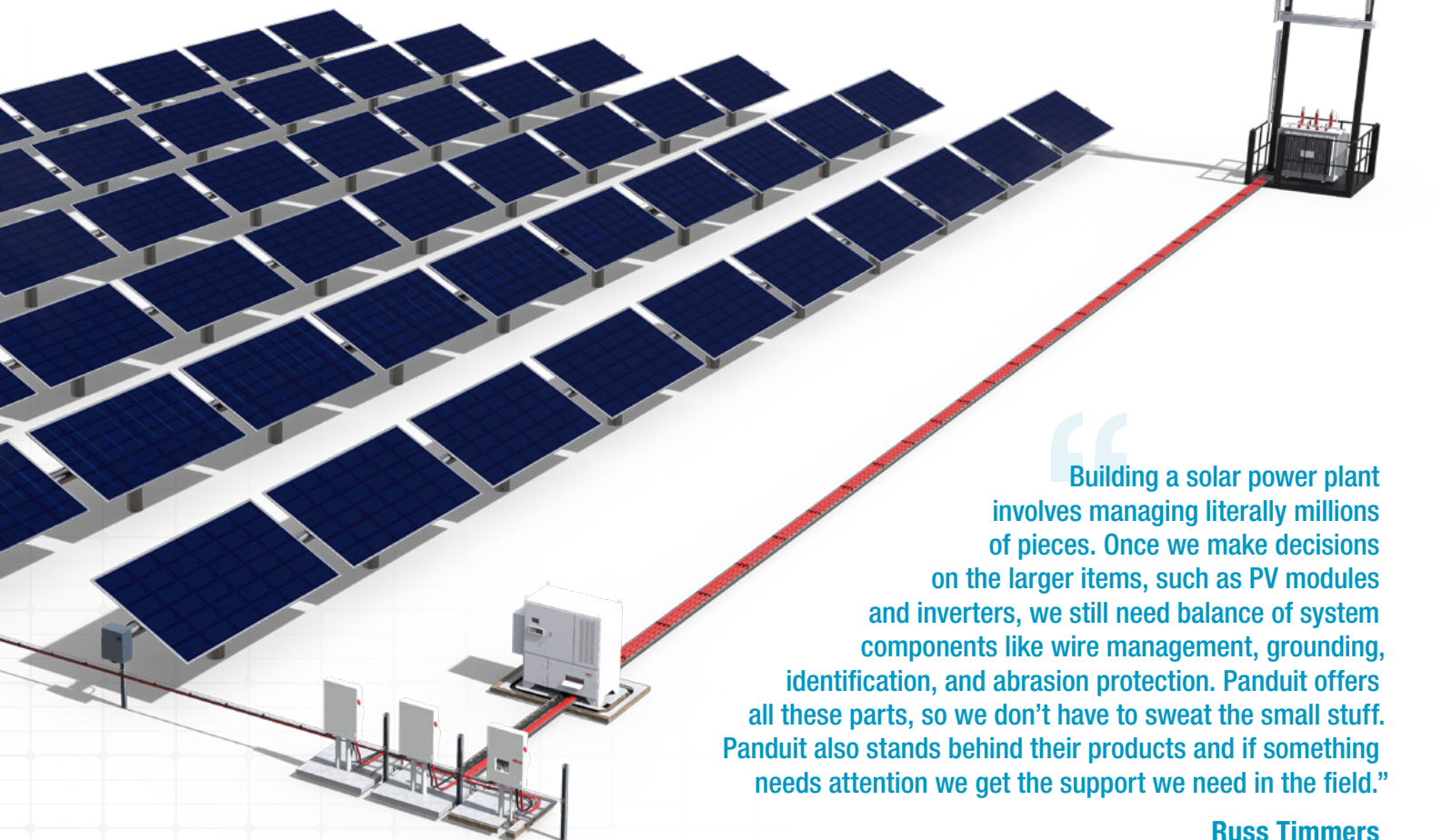

“Building a solar power plant involves managing literally millions of pieces. Once we make decisions on the larger items, such as PV modules and inverters, we still need balance of system components like wire management, grounding, identification, and abrasion protection. Panduit offers all these parts, so we don’t have to sweat the small stuff. Panduit also stands behind their products and if something needs attention we get the support we need in the field.”

Russ Timmers
VICE PRESIDENT
SARGENT ELECTRIC COMPANY

Balance of System (BOS) Can Drive ROI

Our BOS solutions play a key role at every stage of the solar power production system. They are designed with installers in mind to simplify processes and built to last for project performance. Maximizing labor resources from start to finish.

Beyond best-in-class product solutions, we can streamline procurement with our broad portfolio and experienced team. We will handle the details, so your project doesn't stall for lack of components and leave your crew idle.

Let us create your next solar Bill of Materials (BOM) proposal for you – at no charge. Our Technical Service Engineers will review your project drawings or takeoff, select the best product solutions, and calculate quantities. Send your project drawings or takeoff to renewableenergy@panduit.com.



To those building our Renewable Energy future, we're standing right behind you. We proudly back an extensive range of solar cable management solutions with our **Build Solar Better 20 Year Warranty**.
Build with confidence.

Solar BOS Checklist

Available from Panduit

Array

- Bonding Jumpers
- Lay-in Grounding Lugs
- MC4 Connectors
- Edge Clips
- Nylon 612 Cable Ties
- PV Wire
- PVC Conduit
- Racking
- Solar Wire Hangers
- Solar Safety Labels
- Stainless Steel Locking Cable Ties
- String Wire Harnesses
- Tracker System
- UV Corrugated Loom Tube

DC Distribution System

- Combiner Boxes
- Electrical Tape
- Ferrules
- Fiber Connectivity
- Home Run Cable Management
- Insulation Piercing Connectors
- Messenger Wire System C-Parts
- Pipe Clamp Grounding
- Power Connectors
- PV Cable
- Solar Safety Labels
- Split Bolt Grounding Lugs
- UV Corrugated Loom Tube
- UV Braided Sleeve
- Wire Identification

Equipment Pad

- Cable Cleats
- Cable Tray
- Compression Grounding Connectors
- Data Monitoring Infrastructure
- DC Disconnect
- Power Lugs
- Solar Safety Labels

Photovoltaic (PV) Module

One Megawatt (MW) of production requires ~2,000 PV Modules. Secure power production from the source.

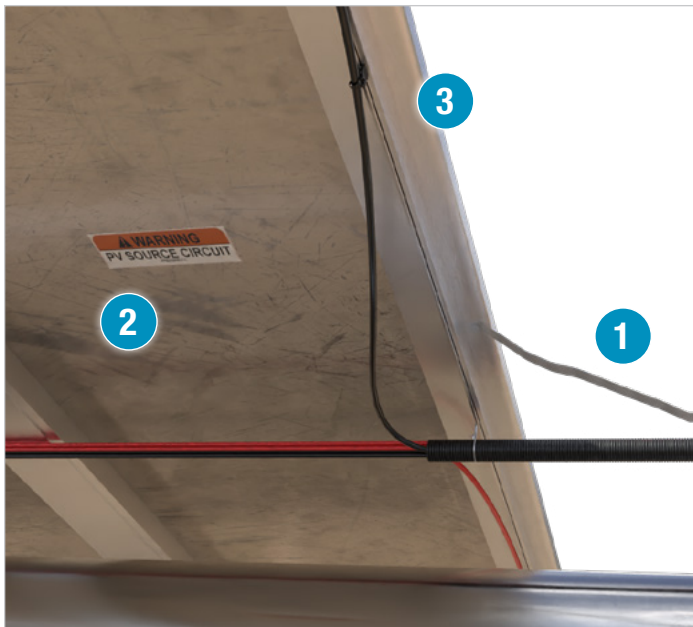

1 CONNECT MODULES & RACKING

Jumper Bonding Straps

BS101245U

Tin-plated to inhibit corrosive effects for improved termination quality of dissimilar materials and listed to UL 467 for bonding applications. Available in various lengths.

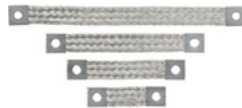

2 LABELS FOR SAFETY

PV Source Labels

PPS0204BLPS-L

Printed on super durable vinyl to provide 7-10 years of life under intense UV. These convenient peel-and-stick labels are available in packs of 50. Complies to NEC2020 and UL standards.



3 ROUTE & SECURE WIRES

Edge Clip Cable Tie

SVSB12-2S-D0

Ideal for suspending PV wire runs from module frames, this clip installs without tools and includes a pre-configured Nylon 6.6 cable tie for fast wire routing.



Edge Clip Without Tie

CME12-M300

Made to mount to PV module edges easily and securely without adhesives, drilling, or tools. Just push on and pair with the cable tie of your choice to manage and route wires.



Stainless Steel Solar Edge Clip

MEC100-2PV-C

These durable metal clips are designed to secure 1, 2, or 4 wires to the edge of PV modules. Simply push on and clip wires under the spring tab for tidy cable management.



Universal Solar Edge Clip

UCCPD-C130

Designed to install in seconds, this clip is great for managing PV wires on back of module. The patented, tool-free clip self-adjusts to various rack sizes, with teeth that lock in place to prevent movement.



Weather Resistant Edge Clip

HCME06A12-M130

Simple push-on clips feature an integral "spring" to hold PV wires tightly on back of module. Made with long-lasting weather-resistant Acetal, available in vertical and horizontal configurations.



Covered by the Panduit Build Solar Better 20 Year Limited Warranty

Array

Manage and protect string bundles to maximize reliable production.

1 MANAGE STRING BUNDLES

Solar Wire Hanger

WH10SS-C

Quickly secure string bundles along solar arrays without tools, using the predrilled holes in PV modules. Solar Wire Hangers can be pre-hung, then filled and clipped closed as you go to hold wires in place.



Coated Stainless Ties

IMLTFC102S-C6L

Versatile, self-locking coated stainless steel cable ties install easily and deliver consistent retention strength without tools. The low thread-force ball head instantly locks to create loops of any diameter, securely holding wire bundles for the life of the project.



Nylon 612 Cable Ties

PLT2S-C6120

The perfect nylon cable tie for solar, resisting degradation from UV exposure up to 10 times longer than standard black ties. Plus, great environmental durability means they stand up to the long-term effects of changing temperatures, humidity, and chemical exposure.



Nylon 6.6 Cable Ties

PLT2S-C0

Proven, weather-resistant cable ties made with Nylon 6.6. Featuring curved tip for easy pick up and faster initial threading.

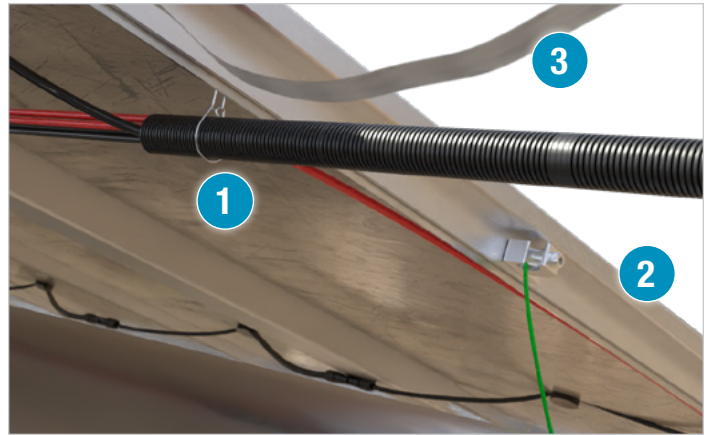

2 CONNECT TO GROUND

Mechanical Lay-in Lug

LIAS4-Q

Tin Plated Lay in Lug is used to connect grounding electrode conductors to a galvanized steel or anodized aluminum I-beam, a metal frame or cable tray. Eliminates need to pre-drill.



3 PROTECT BUNDLES FROM ABRASION

UV Corrugated Loom Tube

CLT150PUV-0

Protect cables from pinch, impact, and abrasion, especially around moving trackers. UV resistant for long-term solar application performance. Available in diameters from .75 to 1.89 inches.



Braided Sleeve

SE125PS-LQR0

Highly flexible, lightweight protection for wires or cables will not trap heat and humidity. Can be installed after wires are routed and terminated.



Covered by the Panduit Build Solar Better 20 Year Limited Warranty

Combiner Box

Create fast, reliable connections, and simplify future maintenance.

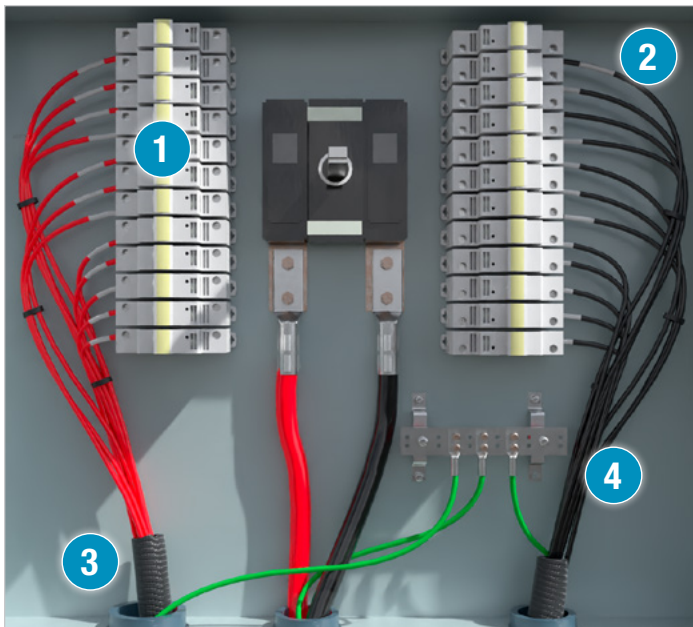

2 PRO WIRE IDENTIFICATION

PXE Handheld Printers

MP300

This super-capable mobile printer is the ideal solution for labeling in the field. Handles die-cut and continuous label sizes up to 1.5 inches with very high resolution. Fast print speeds and automatic cutter keep solar projects moving.



PXE Heat Shrink Labels

H200X165H1T

Quickly and clearly mark wires in-house with TDP43ME desktop units or at the field with mobile PXE printers. Helps create a safer working environment and easier future O&M.



1 QUICK, RELIABLE TERMINATIONS

Ferrules

F83-12-D

Ease insertion of wires into terminal blocks and prevent fraying with ferrules. Available high-quality crimp tools speed termination and improve reliability. UL listed.



Copper Power Lugs

LCA6-38-L

Perfect for high-power, harsh environment solar applications. Tin-plated to inhibit corrosion, they feature a flared barrel for easy wire entry and install simply and securely with a crimp tool. UL compliant with other brand's crimp tools for ultimate process flexibility.



3 PROTECT CABLES IN TIGHT SPACES

Braided Sleeve

SE125PS-LQRO

Highly flexible, lightweight protection for wires or cables can be used in tight spaces. Will not trap heat and humidity.



4 VERSATILE GROUNDING MANAGEMENT

Grounding Busbar

UGB2/0-414-12

The versatile ground busbar is made from 110 electrolytic copper and accepts a wide range of connectors. UL listed.



Home Run

Deliver power to the end of the DC Distribution System.

1 BUNDLE SUPPORT

Dura-Ty™ Kit

DTKH-0

Designed specifically for outdoor power applications, Dura-Ty is an easy-to-use and cost effective way to suspend home run cables from a messenger wire. Available pre-cut or in cut-to-size configurations for process optimization.

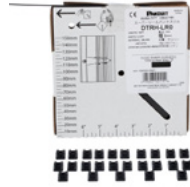

Dura-Ty Spacers

SACS50-T100

Used to create and customize the amount of clearance between suspended cable bundles and messenger wire. Snap together to increase spacer height by 0.5 inch. For use with Dura-Ty Cable Ties.



Aerial Support Tie

AST25-5-C100

A tool-free way to support cable bundles up to 2.5 inches in diameter with built-in spacer to create messenger wire clearance. Releasable and re-usable.



PROTECT FROM PINCH, CRUSH, & UV

UV Corrugated Loom Tube

CLT150PUV-0

Protect cables from pinch, impact, and abrasion, especially around moving trackers. UV resistant for long-term solar application performance. Available in diameters from .75 to 1.89 inches.



2 CONNECT TO GROUND

Split Bolt Connectors

SBC8-C

An internal pressure bar provides secure connection on a full range of conductor combinations. Made from high-strength copper alloy to provide premium electrical and mechanical performance.

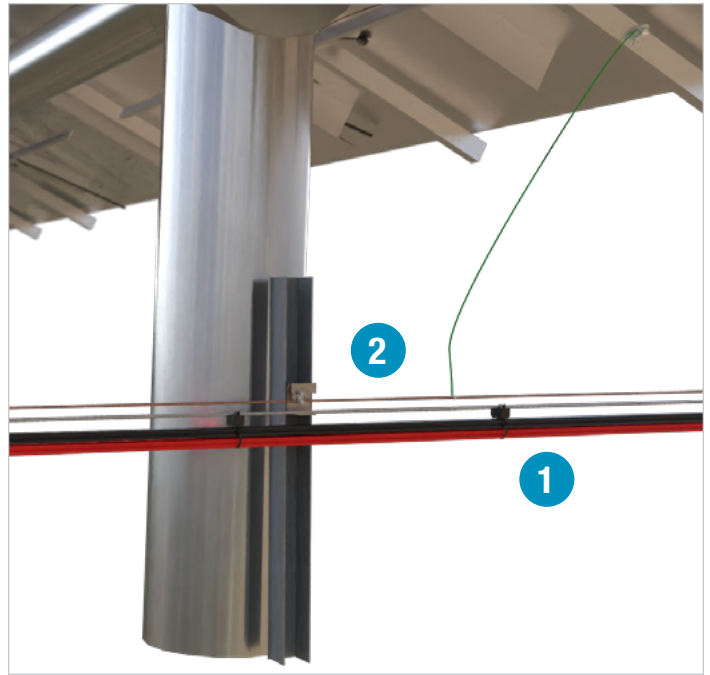

As with any rapidly growing industry, it can be difficult to find enough skilled labor to build solar installations. We can help proactively improve project quality through “process design” to help eliminate errors from undertrained technicians.



Covered by the Panduit Build Solar Better 20 Year Limited Warranty

Disconnect

Quickly and safely interrupt power production.

1 ID FOR SAFETY

PV Disconnect Solar Labels

PPS0204BLDD-L

Printed on super durable vinyl to provide 7-10 years of life under intense UV. These convenient peel-and-stick labels are available in packs of 50. Complies to NEC2020 and UL standards.



PXE Heat Shrink Labels

H200X165H1T

Military-Grade Polyolefin single-sided printable labels offer crisp, clear legends with superior legibility for identifying wires and cables. Designed for use with Panduit TDP desktop printers. 3:1 shrink ratio.



Stronghold Electrical Tape

ST35-075-66WH

Pressure-sensitive vinyl electrical tape applies easily and provides a high level of performance over a range of temperatures. Excellent elasticity and insulating properties.



2 EASY, SECURE, POWER CONNECTIONS

Copper Power Lugs

LCCF2/0-14B-X

Perfect for high-power, harsh environment solar applications. Tin-plated to inhibit corrosion, they feature a flared barrel for easy wire entry and install simply and securely with a crimp tool. UL compliant with other brand's crimp tools for ultimate process flexibility.



Aluminum Power Lugs

LAB350-12-XR

A perfect choice for terminating long cable runs. Factory pre-filled with antioxidant and tin-plated to inhibit corrosion, they install simply and securely with a crimp tool.



3 CONNECT TO GROUND

Corrosion Resistant Grounding Clamp

GPL-39-3

U-Bolt Grounding Clamp can be installed in two configurations to accommodate a wide range of pipe, tube, rod, and conductor sizes to minimize inventory requirements. UL 467 Listed for direct burial.



Nylon 612 is the perfect material for a solar cable tie. With characteristics of both nylon 6 and nylon 12, it can withstand up to 10 times the UV exposure of standard black cable ties and has excellent environmental durability.

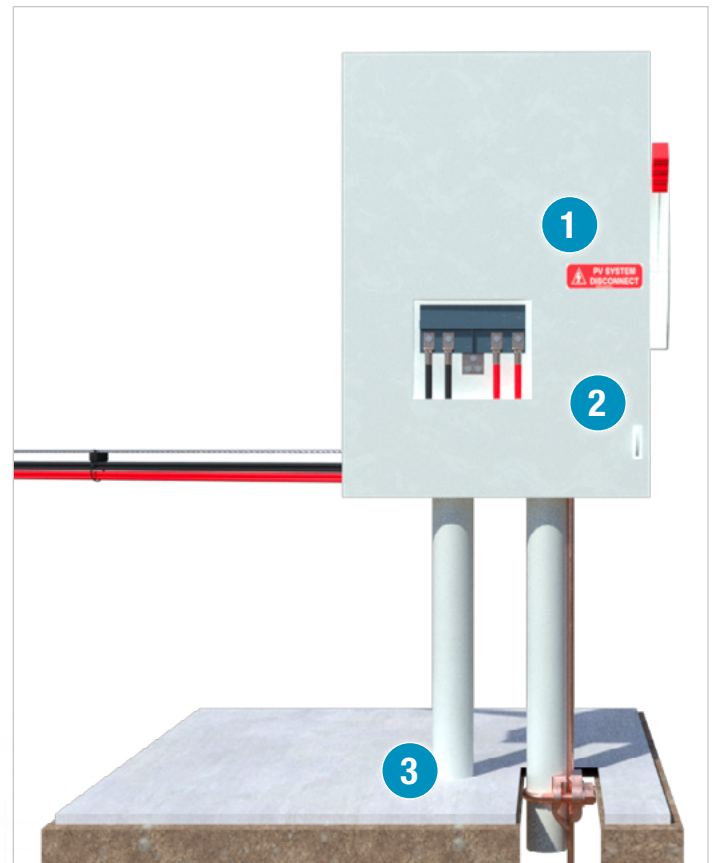

Inverter

Converting DC power to AC power for the grid.

1 SECURE CABLES IN CASE OF FAULT

Cable Cleats

CCSSTR2632-X

The best way to secure and manage the large cables necessary at the end of the DC distribution chain supplying power to and from inverters and battery storage. Keep cables contained in the event of a short circuit fault, preventing harm to people and property. Tested to IEC61914, the latest globally recognized testing standard.



Stainless Steel Buckle Straps

MS8W75T30-Q6

An effective option for protecting against high short circuit fault current requirements in harsh environments. Compatible with quad, trefoil, and multicore cables. Tested to IEC61914, up to 188kA peak fault current.

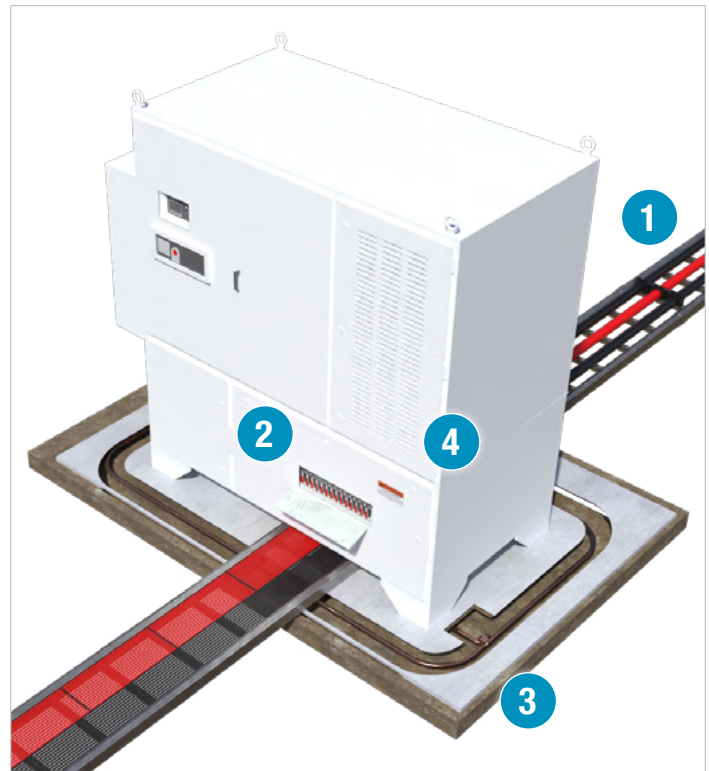

2 EASY, SECURE, POWER CONNECTIONS

Aluminum Power Lugs

LAB750-12-24R

Appropriate for terminating larger cables in harsh environment applications. Factory pre-filled with antioxidant and tin-plated to inhibit corrosion, they install simply and securely with a Blackfin™ crimp tool.



3 CONNECT TO GROUND

Grounding Compression Connectors

GCE250-250-Q

Simplify the process of creating a high-quality electrical bond in the field. No need to deal with exothermic welding kits that can be hard to handle in windy or wet conditions. Just select the right Blackfin tool and die to create a UL certified bond in moments.



4 LABEL FOR SAFETY

Solar Warning Labels

PPS0204WL6-L

One of 32 pre-printed safety & hazard peel-and-stick solar label offerings, which can also be made in-house with the TDP43ME desktop printer using our blank solar label roll for cost savings and just-in-time flexibility.



Let us create your next solar BOM proposal for you – at no charge. Our Technical Service Engineers will review your project drawings or takeoff, select the best product solutions, and calculate quantities.

Send your solar project drawings or takeoff to renewableenergy@panduit.com

Data Monitoring Solutions

Stay connected to system performance with durable harsh-environment components.

COPPER SOLUTIONS

Find the greatest value on the market, secure future reliability, and provide the foundation for network growth for harsh environmental conditions.



Industrial Copper Cable

The Cat 6A SF/UTP copper cable is constructed of 24/7 AWG stranded copper conductors with HDPE polyethylene insulation. The copper conductors are twisted in pairs and wrapped with a foam polypropylene tape to form a core.

Industrial Copper Faceplates, Outlets & Panels

The IndustrialNet™ Copper DIN Rail Patch Panel is constructed of high impact polycarbonate material. This 8-port DIN rail patch panel mounts to a standard 35 millimeters DIN rail and includes adjustable latches to lock in place.



Industrial Copper Patch Cords

The IndustrialNet Cat 5e Shielded Patch Cord is constructed of industrial grade, 24 AWG, SF/UTP, twisted pair, stranded, CM cable with industrial bulkhead shielded modular plugs with black strain relief boots.



Industrial Copper Connectors

The IndustrialNet Cat 5e UTP bulkhead RJ45 coupler module with protective cap is ideal in manufacturing environments. The bulkhead provides an IP67 rated seal that provides protection from dust and temporary immersion in water.



HARSH ENVIRONMENT FIBER SOLUTIONS

Industrial Fiber Optic Systems provide advanced bandwidth with comprehensive fiber optic systems that deliver high performance, reliability, and scalability to industrial environments.



Industrial Fiber Cable

From indoor to indoor/outdoor to outside plant cables, we offer a wide range of fiber optic cables that are easy to install and provide high-density connectivity.

Industrial Fiber Optic Faceplates, Outlets & Adapters

The IndustrialNet 8-port DIN Rail Fiber Optic Patch Panel provides fiber protection for terminated distribution style cabling. It can be mounted to a standard 35 millimeters DIN rail and locked in place with adjustable latches, which are designed to allow it to mount on a flat surface.



Outdoor Fiber Closures and Accessories

Elevate your industrial network with our Fiber Optic Systems, designed to meet your advanced bandwidth needs and enhance your physical infrastructure. Our comprehensive solutions not only deliver high performance, reliability, and scalability but also expertly organize, manage, and protect your fiber optic cables and splices.



Data Monitoring Solutions

FIBER CONNECTIVITY SOLUTIONS

Enhance your fiber optic system with an assortment of fiber optic panels, cassettes, and enclosures.



Fiber Optic Cassettes

The HD Flex™ Cassette is OM4 MPO to LC and supports 12 fibers total. It is Ultra IL and uses Method A polarity. The cassette has a black cover with a black MPO connector and 6 aqua duplex LC adapters with integral shutters to prevent contamination.

Fiber Optic Enclosure Accessories

Opticom® Fiber Splice Module holds and protects up to 24 fusion and 144 ribbon splices within Panduit Opticom Rack Mount Fiber Enclosures. The self-stacking modules stack 4 high and provide the perfect amount of fiber slack or spool for long-run installations or high-bandwidth applications.

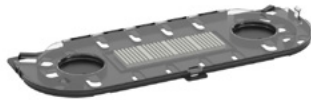

Fiber Optic Enclosures

The HD Flex Fiber Enclosure is 1 RU and is configured with sliding front-access drawers to accept up to twelve 6 port HD Flex cassettes or Fiber Adapter Panels for a maximum density of 144 fibers.



Fiber Optic Panels

The Opticom LC Fiber Adapter panel is OS2 and is loaded with 12 LC Duplex Fiber Optic Adapters. The Fiber Optic Adapters are blue with zirconia split sleeves.



UNINTERRUPTIBLE POWER SUPPLIES (UPS)

Delivering highly efficient and reliable power protection and backup power for your computer IT equipment, the Uninterruptible Power Supply provides excellent electrical performance, intelligent battery management, and enhanced intelligent monitoring.



UPS

Provides excellent electrical performance, intelligent battery management, enhanced intelligent monitoring, secure network functions and long lifespan for lithium units. Highly efficient, reliable power protection and backup.

Industrial Uninterruptible Power Supplies (IUPS)

The IUPS is maintenance free and requires no battery. The UPS is 100W and is 24 VDC. The ultracapacitor technology reduces the risk of downtime from battery failures and saves expenses on battery inspections and replacement.



Batteries

Enhance the production of your UPS with accessories including batteries, tower stabilizer brackets, and network management cards.

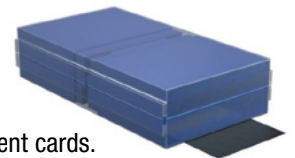

Environmental & Security

Power distribution, environmental, humidity sensors and connectivity systems improve availability, scalability, power, cooling efficiency, and product quality leading to a decrease in network downtime and increase in data center productivity.



Labels & Printers

Hazard, safety, and wire ID, we offer a complete solar labelling solution.

WIRE IDENTIFICATION

Save hours of troubleshooting time with clearly identified wires and cables that help technicians quickly go to the source of the problem.

Heat Shrink Labels

Offering crisp, clear legends with superior readability for quick and easy label production. Designed to provide a clear, reliable, and durable way to identify wires and cables.



Turn-Tell Labels

Innovative self-laminating label can be rotated for improved visibility on wires and cables. Easy to install on existing terminated wires.



HAZARD & SAFETY LABELS

Create and maintain a safe working environment by clearly identifying hazards.

Detectable Hazard Tapes

Underground hazard tape designed for safety identification for outdoor applications.



Safety Identification

Identify hazards and eliminate guesswork when identifying power sources with OSHA and ANSI compliant layouts and colors to communicate safety messages.



The sheer number of labels required for solar presents an opportunity for process optimization. If you're building multiple sites, in-house desktop printing ensures you always have just what you need to keep a project on track, while reducing costs. And equipping field crews with corresponding mobile units creates consistency, flexibility, and legibility when marking wires.

▶ [Discover the Best Labeling Solutions for Maximum Efficiency](#)



MOBILE & DESKTOP PRINTERS

Simplify procurement and maintain standards by printing your own high-quality labels

Mobile

The MP300 and MP200 mobile printers are ideal for printing labels on the job site up to 1.5 inches wide. Best-in-class automatic cutter for full and half cuts, up to 360 dpi resolution, and fast printing speed.



Desktop Printers

Thermal transfer desktop printers allow printing up to 8 inches per second with professional 300 or 600 dpi resolution on labels and tapes up to 4 inches wide. Compact for mobility and easily deployable, they require minimal setup and calibration to save time.



Identification Software

Easy-Mark Plus™ Labeling Software helps create industry-compliant labels for solar environments and saves up to 75% of the time required to generate labels by using previously created CAD files to eliminate manual entry.



Pre-Printed PV System Labels

Designed to meet the required safety standards for PV installation labeling. Extremely UV resistant with strong holding power for outdoor applications on rough, textured, and powder-coated surfaces.

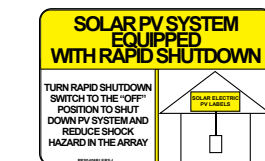
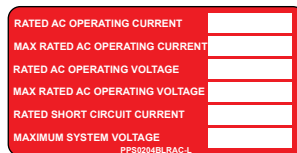
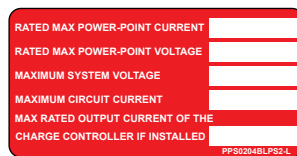
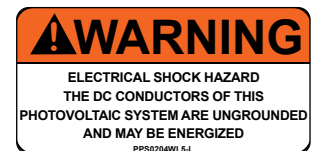
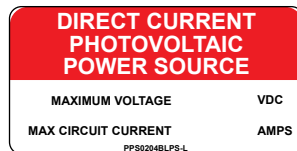
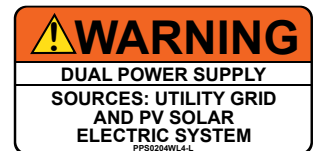
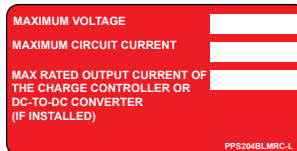
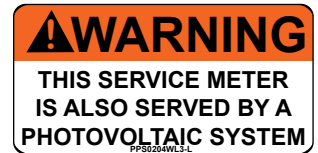
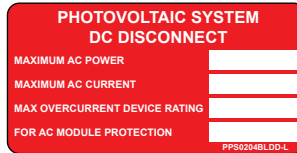
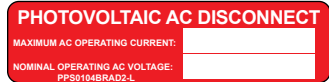
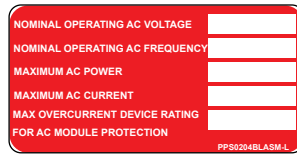

Build Solar Better

20 Year Panduit Solar Warranty

Nylon 612 Cable Ties

PLT2S-C6120

Cable ties designed for solar applications. High resistance to UV light and corrosive elements.



Nylon 12 Cable Ties

PLT2S-C120

Premium cable ties designed for solar applications. High resistance to UV light and corrosive elements.



Dura-Ty Extruded Strap and Heads

DTKH-0

Created for harsh outdoor power and communications applications, ideal for larger home-run bundles.



Composite Edge Clip (No Ties)

CMS12-M300

Versatile mounting to PV module edges without adhesives or drilling. Pair with cable tie to secure and route wires.



Universal Solar Edge Clips

UCCPD-C130

Patented, tool-free clip adjusts to various rack sizes. Great for managing PV wires on solar panels.



Stainless Steel Solar Edge Clips

MEC100-2PV-C

Durable metal clip designed to secure 1, 2, or 4 wires to the edge of PV modules.



Stainless Steel Wire Hangers

WH10SS-C

Quickly suspend string bundles along solar arrays using predrilled holes in PV modules.



Stainless Steel Cable Ties

IMLT102S-C

Contractor Grade – Versatile, self-locking stainless tie installs easily and delivers consistent retention strength without tools.



Fully Coated Stainless Steel Cable Ties

IMLTFC102S-C6L

Contractor Grade – Strong enough to withstand corrosive environments. Self-locking, tool-free, and easy to handle.



Stainless Steel Cable Ties – Premium

MLT4H-LP

Premium, self-locking stainless tie installs easily and delivers consistent retention strength without tools.



Build Solar Better

20 Year Panduit Solar Warranty

Coated Stainless Steel Ties – Premium

MLTFC4S-CP316

Premium performance in corrosive environments. Self-locking, tool-free, easy to handle and thread.



Weather Resistant Edge Clip

HCME06A12-M130

Simple push-on clips feature an integral “spring” to hold PV wires tightly on back of module. Made with long-lasting weather-resistant Acetal, available in vertical and horizontal configurations.



ETFE Cable Ties

PLT2S-C76

Specialty cable ties designed to resist chemicals, UV radiation, and extreme temperatures.



ETFE Cable Tie Mount

TM3S10-C76

Specialty cable tie mounts designed to resist chemicals, UV radiation, and extreme temperatures.



We proudly back this extensive range of solar cable management solutions with our **20 Year Build Solar Better Warranty.**

Whether your project requires clips or cable ties, in metal or plastic, you can count on our solutions for long-term performance.

Standard Global Capabilities

Global Expertise and Support

Global distribution, manufacturing, sales and technical support teams make Panduit solutions readily accessible, allowing the right products to be delivered when and where they are needed.

Worldwide Certifications

Panduit solutions hold a variety of the most common heavy industry certifications and approvals worldwide.

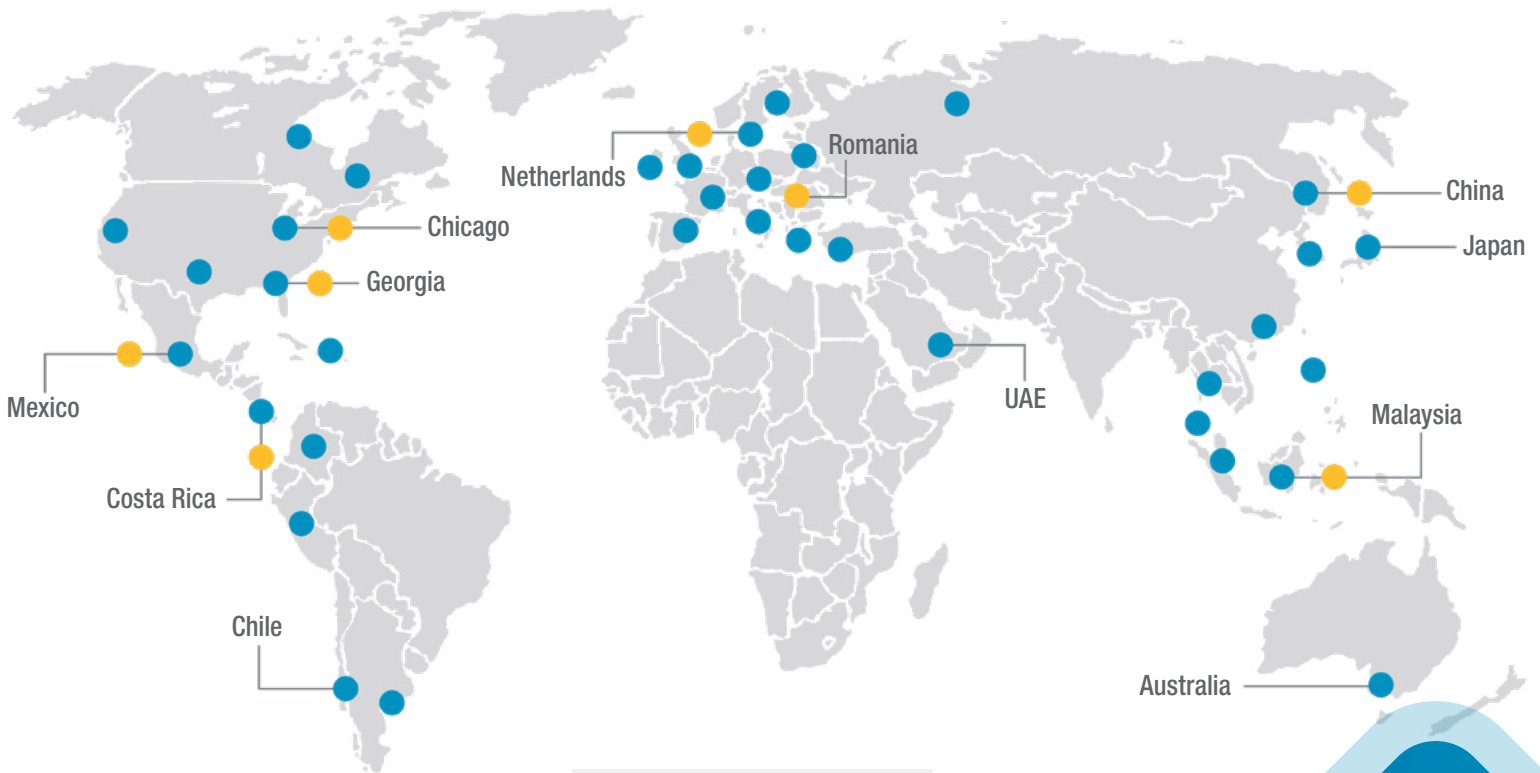

- Primary Offices
- Manufacturing Facilities

Panduit Corp.
World Headquarters
Tinley Park, IL 60487

cs@panduit.com

US and Canada: 800.777.3300

Europe, Middle East, and Africa:

44.20.8601.7200

Latin America: 52.33.3777.6000

Asia Pacific: 65.6305.7575

www.panduit.com/solar



Let's Chat!

Connect With a Renewable Energy Expert – Panduit

PANDUIT®